



Approved by:
Checked by:
Issued by:

SPECIFICATION

PRODUCT: SAW FILTER

MODEL: HB4302N (X6964D) SIP5D

HOPE MICROELECTRONICS CO., LIMITED

1. Construction

1.1 Dimension and materials

Type : B4302N

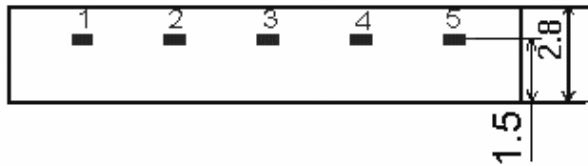

Unit : mm

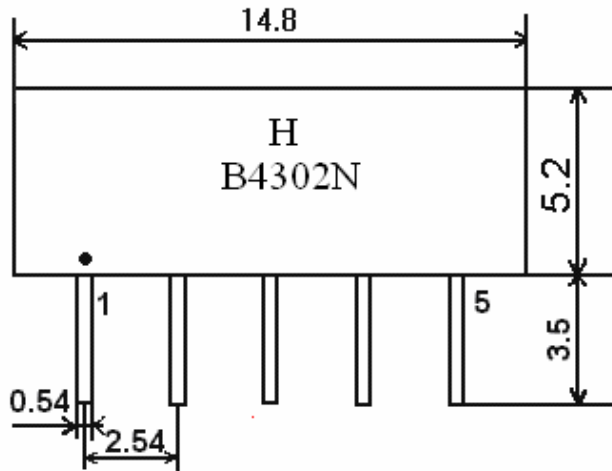

- 1 Input
- 2 Input ground
- 3 Chip carrier - ground
- 4 Output
- 5 Output

1.2. Circuit construction, measurement circuit

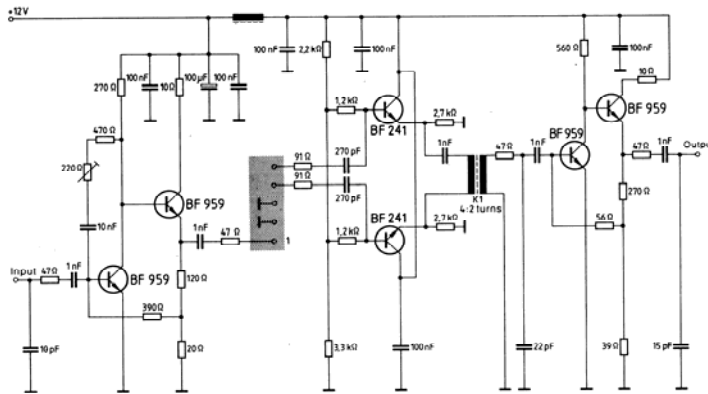

Test circuit for SIP-5 filter
Input impedance of the symmetrical post-amplifier: 2 kΩ in parallel with 3 pF

2.Characteristics

Standard atmospheric conditions

Unless otherwise specified , the standard rang of atmospheric conditions for making measurements and tests is as follows;

- Ambient temperature : 15°C to 35°C
- Relative humidity : 25% to 85%
- Air pressure : 86kPa to 106kPa

Operating temperature rang

Operating temperature rang is the rang of ambient temperatures in which the filter can be operated continuously. $-10^{\circ}\text{C} \sim +60^{\circ}\text{C}$

Storage temperature rang

Storage temperature rang is the rang of ambient temperatures at which the filter can be stored without damage.
Conditions are as specified elsewhere in these specifications. $-40^{\circ}\text{C} \sim +70^{\circ}\text{C}$

Reference temperature $+25^{\circ}\text{C}$

2.1 Maximum Rating

DC voltage	VDC	12	V	Between any terminals
AC voltage	Vpp	10	V	Between any terminals

2.2 Electrical Characteristics

Source impedance

$Z_S=50\ \Omega$

Load impedance

$Z_L=2\text{k}\ \Omega //3\text{pF}$

$T_A=25^{\circ}\text{C}$

	Freq	min	typ	max	
Center frequency	F ₀	43.71	43.81	43.91	MHz
Insertion attenuation Reference level	43.81MHz	13.0	14.8	16.6	dB
Pass bandwidth	B _{3dB}	-	6.0	-	MHz
	B _{30dB}	-	7.0	-	MHz
Relative attenuation	41.28MHz	-	0.3	-	dB
	46.34MHz	-1.0	0.2	1.4	dB
	40.81MHz	1.2	2.7	4.2	dB
	46.81MHz	1.2	2.7	4.2	dB
	39.81MHz	36.0	52.0	-	dB
	47.81MHz	35.0	50.0	-	dB
Sidelobe	35.06~39.06MHz	38.0	47.0		dB
	39.06~39.81MHz	35.0	41.0		dB
	47.81~50.06MHz	34.0	40.0		dB
	50.06~55.06MHz	38.0	45.0		dB
Reflected wave signal suppression 1.3 us ... 6.0 us after main pulse (test pulse 250 ns , carrier frequency 43.81 MHz)		42.0	52.0		dB
Feedthrough signal suppression 1.3 us ... 1.2 us before main pulse (test pulse 250 ns , carrier frequency 43.81 MHz)		45.0	54.0		dB

Group delay ripple (p-p) 40.81 ~ 46.81 Mhz	-	50	-	ns
Impedance at 43.81 Mhz	-	-	-	-
Input: $Z_{in} = R_{in} // C_{in}$	-	1.1//16.4	-	k Ω // pF
Output: $Z_{in} = R_{in} // C_{in}$	-	1.1//5.0	-	k Ω // pF
Temperature coefficient	-72			ppm/K

2.3 Environmental Performance Characteristics

Item Test condition	Allowable change of absolute Level at center frequency(dB)
High temperature test 70°C 1000H	< 1.0
Low temperature test -40°C 1000H	< 1.0
Humidity test 40°C 90-95% 1000H	< 1.0
Thermal shock -20°C==25°C==80°C 20 cycle 30M 10M 30M	< 1.0
Solder temperature test Sold temp.260°C for 10 sec.	< 1.0
Soldering Immerse the pins melt solder at 260°C+5/-0°C for 5 sec.	More then 95% of total area of the pins should be covered with solder

2.4 Mechanical Test

Item Test condition	Allowable change of absolute Level at center frequency(dB)
Vibration test 600-3300rpm amplitude 1.5mm 3 directions 2 H each	<1.0
Drop test On maple plate from 1 m high 3 times	<1.0
Lead pull test Pull with 1 kg force for 30 seconds	<1.0
Lead bend test 90° bending with 500g weigh 2 times	<1.0

2.5 Voltage Discharge Test

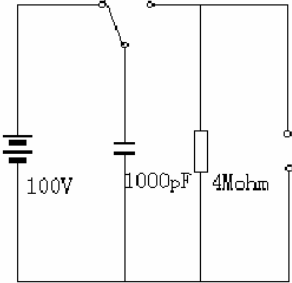
Item Test condition	Allowable change of absolute Level at center frequency(dB)
Surge test Between any two electrode 	<1.0

2.6 Frequency response:

▶1: Transmission /M Log Mag 10.0 dB/ Ref -15.00 dB
 ▶2: Off

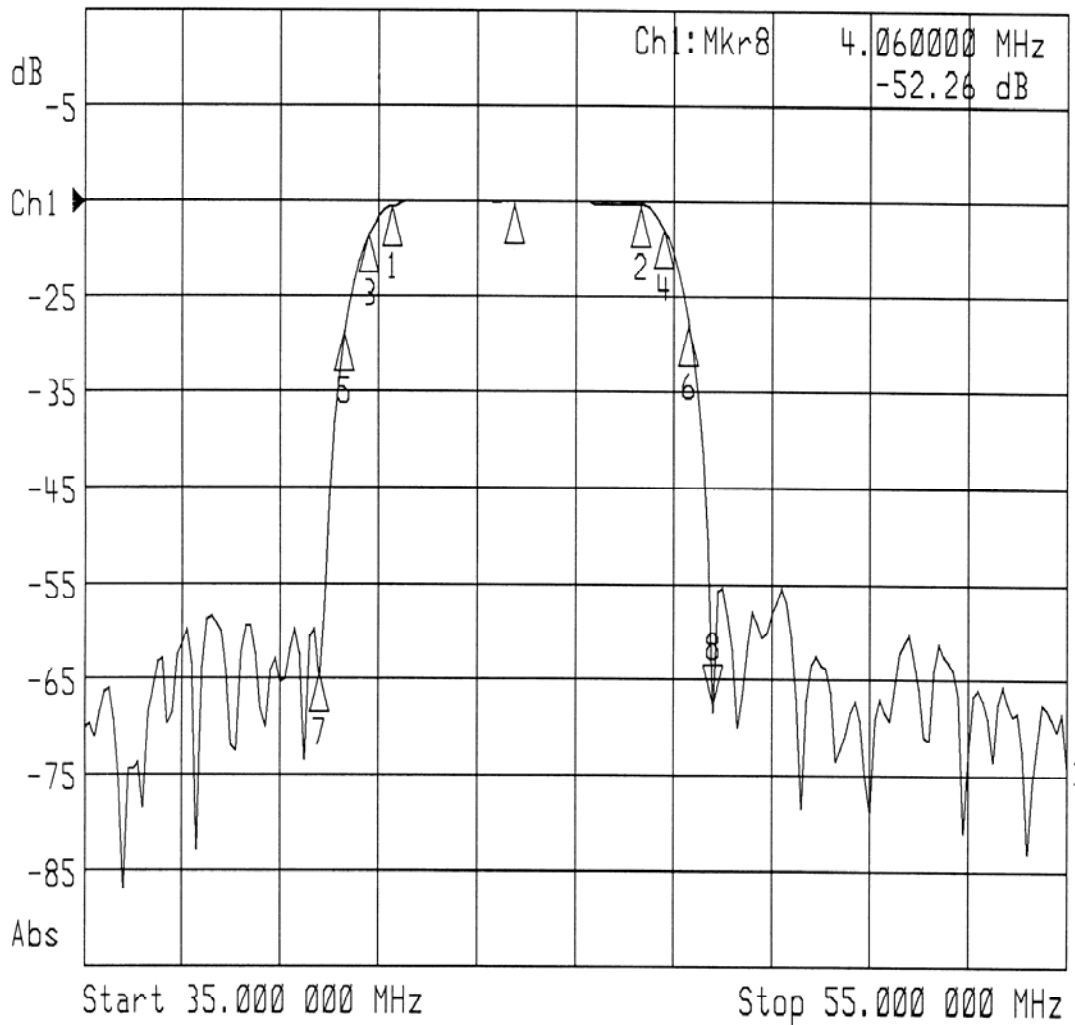

CH1 S21 delay 30 ns/ REF 1.183 μ s 3 1.2189 μ s
CH2 S21 log MAG 1 dB/ REF -14.88 dB 3: .0192 dB

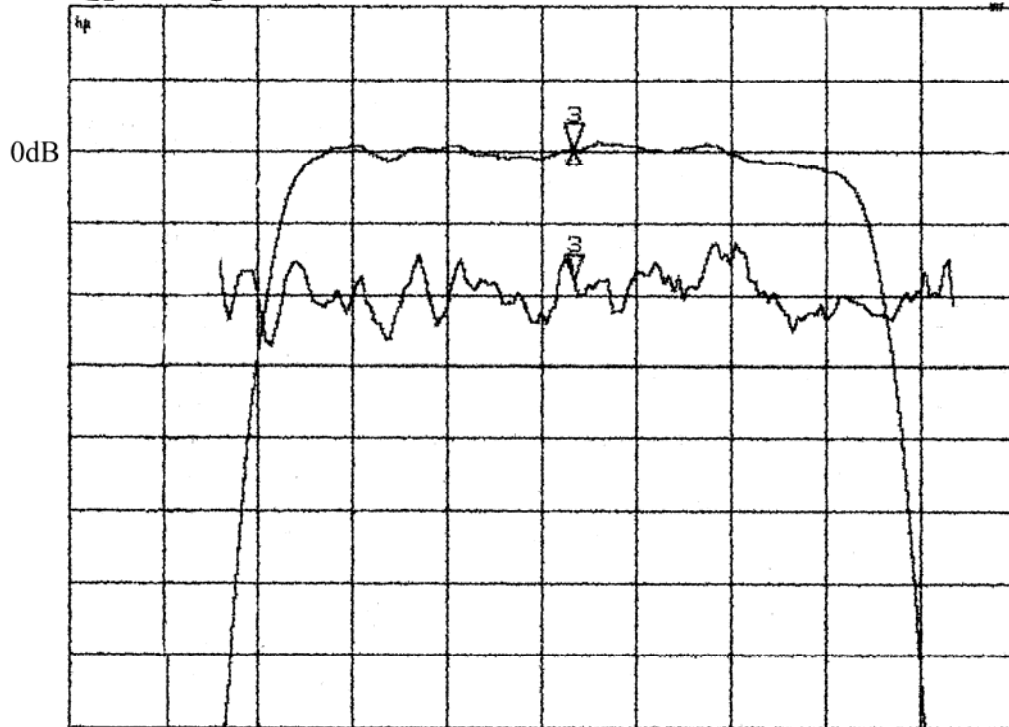

START 39.000 000 MHz STOP 48.000 000 MHz

CH2 S21 log MAG 10 dB/ REF -16.23 dB

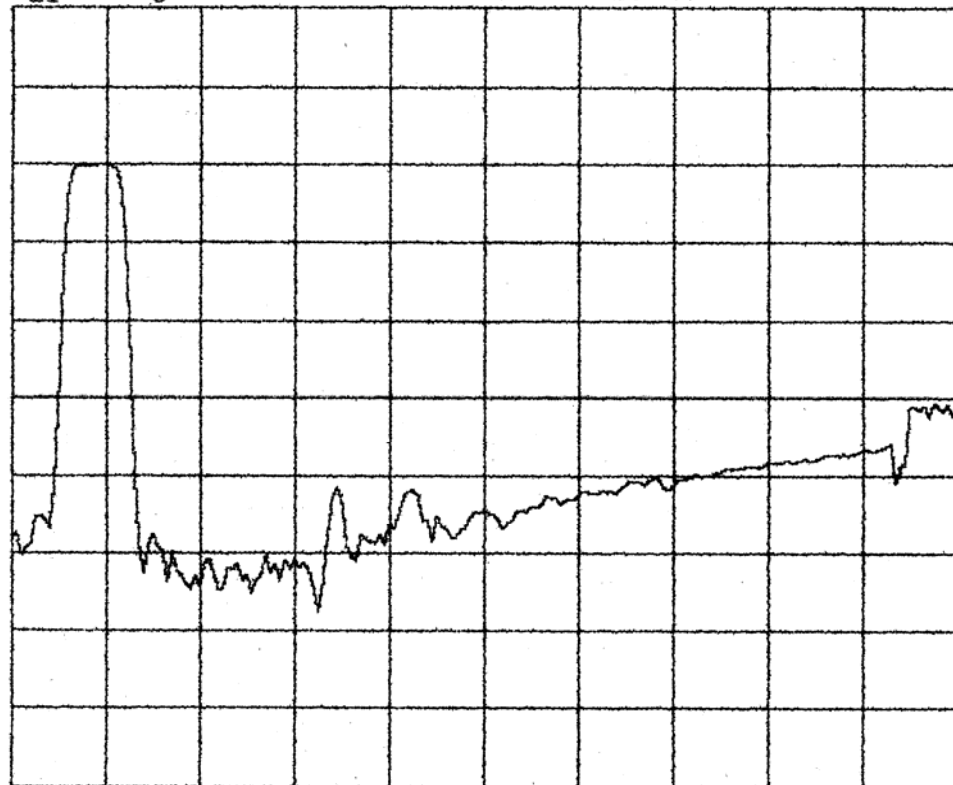

START 35.000 000 MHz STOP 135.000 000 MHz

Time domain response:

